

**SPECIFICATION SHEET**

**PROJECT No:**  
\_\_\_\_\_

**"NON-IC" TYPE HOUSING**

NW4000E 120/12V

-  **yes**

---

- VOLTAGE 120 VOLTS**

---

-  **12 V 35W max.**

---

- 

---

- 

---

- 

---

-  **Electronic Transformer**  
**120V / 12V**

---

-  **T°C 120°C No 031**

---

- Double top

UL number : **E 174023**  
E Electronic M Magnetic C Short L Long

**AVAILABLE TRIMS**  
T4000, T4200, T4210V, T4300

 **OD Cut : 3 5/16" (84 mm)**

NOTES:  
For ceiling without insulation  
Below ceiling access

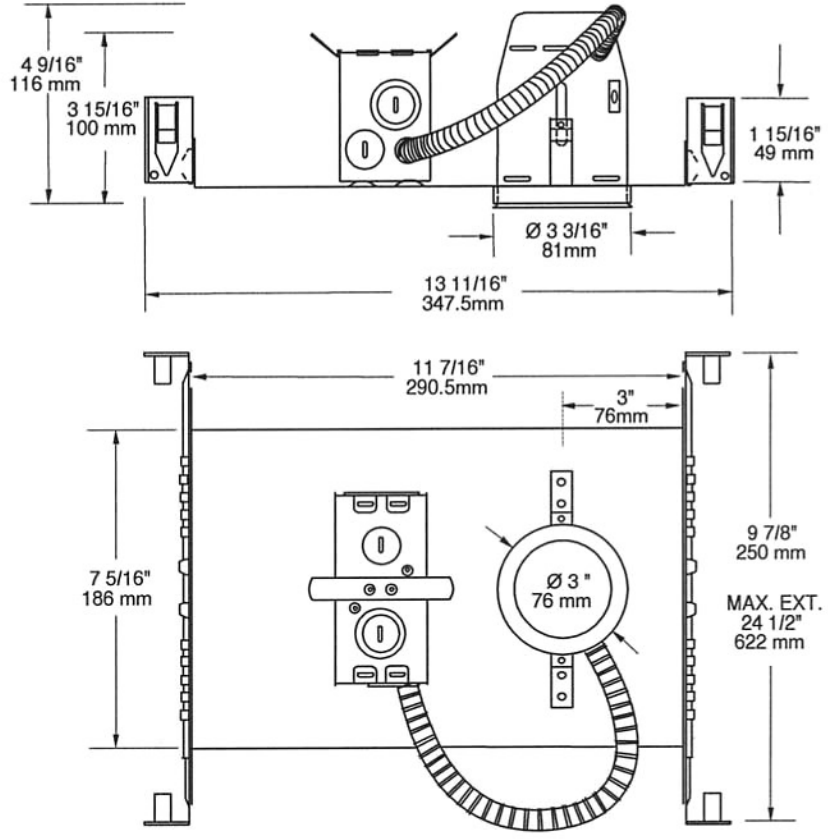

**PROJECT**

Your Project: \_\_\_\_\_  
\_\_\_\_\_  
\_\_\_\_\_

Representative: \_\_\_\_\_