









**8" HID SERIES**

# NWMH8MEDU70

**NEW CONSTRUCTION HOUSING FOR HID METAL HALIDE LAMP**



	Yes
<b>Damp location</b>	
	MH 70 W Medium base ANSI: M90/C90/M140/C140
<b>HID</b>	
	120/277V (CAN & USA)
<b>Voltage</b>	
	<b>Electronic ballast</b> Minimum starting temperature: -15°C (5°F) RoHS compliant
<b>Ballast</b>	
	Inductive thermal protector
	9 1/4" (235 mm)
<b>Ceiling Cutout</b>	
	E331150
	<b>Overall dimensions</b> Length: 19 3/32" (485 mm) Width: 11 1/4" (286 mm) Height: 9 1/8" (232 mm)
<b>Dimensions</b>	

**COMPATIBLE TRIMS**  
MHR8VOM

**ORDERING CODE: NWMH8MEDU70**

Housing type	Series	Base type	Ballast/ Voltage	Wattage
NWMH	8	MED	U	70
New constructor HID	8"	Medium base	120/277V	70W

**ADDITIONAL SPÉCIFICATIONS**

Below-ceiling accessible.  
 Hooks PAT#CAN 2,088,648 and #USA 5,377,088.  
 Fits ceiling up to 7/8" thick ceiling.  
 Perfect fit into ceiling.  
 No light leakage.  
 Each part of the case should be at 3 "(76mm) away MINIMUM from insulation (if applicable).  
 660W /600V socket, with 4 kV pulse rating.  
 Ballast: 3 year Warranty.

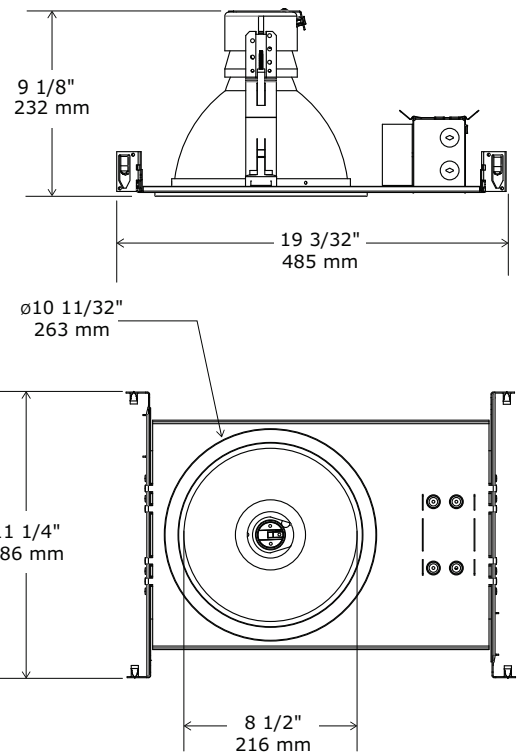

Project \_\_\_\_\_

Representative \_\_\_\_\_