

UR3B

3-1/2" Series Square Adjustable Trim



Project _____

Notes _____

Fixture Type _____

Date _____



UR3B-11 (illustrated)

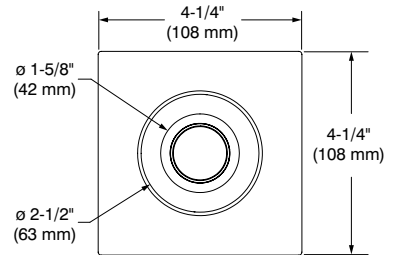
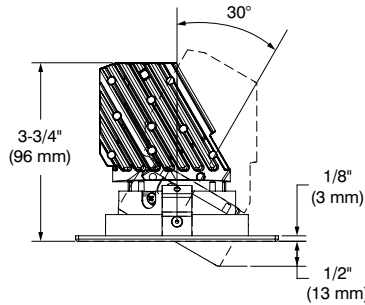

SPECIFICATIONS

LED MODULE

SOLID COLORS

Lumileds Luxeon CoB
 2,700K - CRI: 80+ and 90+
 3,000K - CRI: 80+ and 90+
 3,500K - CRI: 90+
 4,000K - CRI: 90+
 Lumens Maintenance:
 L₇₀ @ 50,000 hours
 Binning: 3 SDCM

LED MODULE (CONT'D)

WARM DIMMING (WD)

LED module mimicking the halogen lamp dimming conditions by lowering color temperature from 3,050K at full intensity down to 1,800K at low-end while ensuring 90+ CRI throughout the whole process.
 Lumens Maintenance:
 L₇₀ @ 50,000 hours
 Binning: 3 SDCM

DELIVERED LUMENS

Performance 1 (10W):
1,018 lumens @ 3,000K, 101.8 lms/W
Performance 2 (15W):
1,326 lumens @ 3,000K, 88.4 lms/W
Warm Dimming (15W):
650 lumens @ 3,000K, 43.3 lms/W

OPTIC SYSTEM*

Optical reflectors available:
 Spot, Narrow Flood, Flood

	Standard
Spot (S)	16°
Narrow Flood (M)	32°
Flood (L)	48°

* Average beams shown. Consult .ies files on our Website for more details.

LENS

Without lens (std)
 Clear (C)
 Frosted (F)
 Honeycomb (H)
 Linear (L)
 Prismatic (P)
 Solite (S)

POWER SUPPLY

(Determined by the choice of housing)
 120V - 277V
 Several driver models available in two performances (10W and 15W) and in two dimming options (ELV and 0-10V).
 See housing specification sheets for more details.

HEAT SINK

High quality aluminum injected heat sink ensuring maximum heat dissipation.

TRIM

Powder coat painted or plated die-formed steel. Tilt: up to 30°.

CEILING CUTOUT

ø 3-3/4" (95 mm)

UR3B

3-1/2" Series Square Adjustable Trim



SPECIFICATIONS (CONT'D)

COMPATIBLE HOUSINGS

	Remodel Housings	New Construction Housings	IC Housings
Performance 1 10W Warm Dimming not compatible	IC and Air Tight REUR3-120D1 REUR3-120E1 REUR3-277D1	IC and Air Tight NWUR3-120D1 NWUR3-120E1 NWUR3-277D1 Emergency Driver Non-IC and Air Tight NWUR3-120D1-EM NWUR3-120E1-EM NWUR3-277D1-EM	Air Tight ISUR3-120D1 ISUR3-120E1 ISUR3-277D1 Chicago Plenum and Polyurethane Air Tight ISUR3-120D1P ISUR3-120E1P ISUR3-277D1P
Performance 2 15W MAX	Non-IC and Air Tight REUR3-120D2 REUR3-120E2 REUR3-120EB2 REUR3-2772 REUR3-277D2	Non-IC and Air Tight NWUR3-120D2 NWUR3-120E2 NWUR3-120EB2 NWUR3-2772 NWUR3-277D2 Emergency Driver Non-IC and Air Tight NWUR3-120D2-EM NWUR3-120E2-EM NWUR3-120EB2-EM NWUR3-2772-EM NWUR3-277D2-EM	Air Tight ISUR3-120D2 ISUR3-120E2 ISUR3-120EB2 ISUR3-2772 ISUR3-277D2 Chicago Plenum Air Tight ISUR3-120D2P ISUR3-120E2P ISUR3-120EB2P ISUR3-2772P ISUR3-277D2P

For dimming, please visit our Web site frequently to find our suggested compatible dimmers list:
www.contrastlighting.com

CODIFICATION EXAMPLE

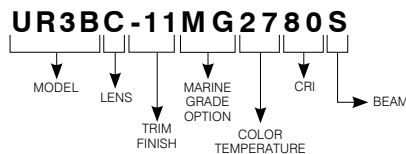

ORDERING CODE

MODEL	LENS	TRIM FINISHES	MARINE GRADE	COLOR TEMPERATURES	CRI	BEAMS
UR3B						
UR3B	Without lens (std)	-03SA Satin Gold	MG (optional)	27 2,700K (80+ and 90+ CRI)	80 80+	S Spot (16°)
	C Clear	-04BR Brushed Chrome	May be applied on finishes: -11 and -22	30 3,000K (80+ and 90+ CRI)	90 90+	M Narrow Flood (32°)
	F Frosted	-11 Matte White		35 3,500K (90+ CRI)		L Flood (48°)
	H Honeycomb	-12BR Brushed Nickel		40 4,000K (90+ CRI)		
	L Linear	-13 Satin Nickel		WD Warm Dimming (90+ CRI)		
	P Prismatic	-22 Matte Black				
	S Solite					

CERTIFICATION

cULus **E343977** for damp locations

WARRANTY

1 year on components against manufacturing defects
 5 years on LED arrays and drivers

CONTRASTE

1009, rue du Parc Industriel
 Lévis (Québec) G6Z 1C5 Canada
 Tel.: 1-888-839-4624
 Fax.: 1-877-839-7057
 contrastlighting.com
 info@contrastlighting.com

© 2017 Contrast Lighting M.L. Inc.
 All rights reserved

Contrast Lighting M.L. Inc. reserves the right to make changes in specifications and/or to discontinue any product at any time without notice or obligation and will not be liable for any consequences resulting from the use of this publication.

SPECIFICATION SHEET

UR3B**3-1/2" Series****Square Adjustable Trim**

GOOF RINGS

Code: RS3-03SA (Satin Gold)
 RS3-04BR (Brushed Chrome)
 RS3-11 (Matte White)
 RS3-12BR (Brushed Nickel)
 RS3-13 (Satin Nickel)
 RS3-22 (Matte Black)

Outside dimensions: 5-1/2" (140 mm) x 5-1/2" (140 mm)
 Inside diameter: \varnothing 3-11/16" (94 mm)

CONTRASTE

1009, rue du Parc Industriel
 Lévis (Québec) G6Z 1C5 Canada
 Tel.: 1-888-839-4624
 Fax.: 1-877-839-7057
 contrastlighting.com
 info@contrastlighting.com

© 2017 Contrast Lighting M.L. Inc.
 All rights reserved

Contrast Lighting M.L. Inc. reserves the right to make changes in specifications and/or to discontinue any product at any time without notice or obligation and will not be liable for any consequences resulting from the use of this publication.

UR3B

3-1/2" Series Square Adjustable Trim



PHOTOMETRIC DATA

With performance 1 housing

	Spot		Narrow Flood		Flood	
2,700K with 80+ CRI	806 lms	80.6 lms/W	994 lms	99.4 lms/W	1,011 lms	101.1 lms/W
3,000K with 80+ CRI	826 lms	82.6 lms/W	1,018 lms	101.8 lms/W	1,035 lms	103.5 lms/W

2,700K with 90+ CRI	670 lms	67 lms/W	826 lms	82.6 lms/W	839 lms	83.9 lms/W
3,000K with 90+ CRI	692 lms	69.2 lms/W	853 lms	85.3 lms/W	868 lms	86.8 lms/W
3,500K with 90+ CRI	731 lms	73.1 lms/W	901 lms	90.1 lms/W	916 lms	91.6 lms/W
4,000K with 90+ CRI	750 lms	75 lms/W	925 lms	92.5 lms/W	941 lms	94.1 lms/W

Performance 1 Housings Factors	
XXUR-120E1	0.90
XXUR-120D1 ou XXUR-277D1	1

With performance 2 housing

	Spot		Narrow Flood		Flood	
2,700K with 80+ CRI	1,050 lms	70 lms/W	1,295 lms	86.3 lms/W	1,316 lms	87.7 lms/W
3,000K with 80+ CRI	1,075 lms	71.6 lms/W	1,326 lms	88.4 lms/W	1,348 lms	89.8 lms/W

2,700K with 90+ CRI	872 lms	58.1 lms/W	1,075 lms	71.6 lms/W	1,093 lms	72.8 lms/W
3,000K with 90+ CRI	901 lms	60 lms/W	1,111 lms	74 lms/W	1,130 lms	75.3 lms/W
3,500K with 90+ CRI	951 lms	63.4 lms/W	1,173 lms	78.2 lms/W	1,193 lms	79.5 lms/W
4,000K with 90+ CRI	977 lms	65.1 lms/W	1,205 lms	80.3 lms/W	1,225 lms	81.6 lms/W
Warm Dimming with 90+ CRI	527 lms	35.1 lms/W	650 lms	43.3 lms/W	661 lms	44 lms/W

Performance 2 Housings Factors	
XXUR-120E2	0.95
XXUR-120EB2, XXUR-120D2, XXUR-2772 ou XXUR-277D2	1

Lens Factors	
STD	1
C	0.97
F	0.68
H	0.54

CONTRASTE

1009, rue du Parc Industriel
Lévis (Québec) G6Z 1C5 Canada
Tel.: 1-888-839-4624
Fax.: 1-877-839-7057
contrastlighting.com
info@contrastlighting.com

© 2017 Contrast Lighting M.L. Inc.
All rights reserved

Contrast Lighting M.L. Inc. reserves the right to make changes in specifications and/or to discontinue any product at any time without notice or obligation and will not be liable for any consequences resulting from the use of this publication.

UR3B

3-1/2" Series Square Adjustable Trim



PHOTOMETRIC DATA

3,000K, 90+ CRI, Spot, Performance 1

CANDLEPOWER DISTRIBUTION

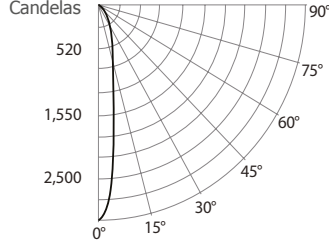

LIGHT CONE

Distance	FC	DIA
06'	85.6	1.7'
08'	48.1	2.3'
10'	30.8	2.9'
12'	21.4	3.5'
14'	15.7	4.1'
16'	12	4.7'

Beam: 16°
Beam Edge defined as 50% of Maximum Nadir Candle-power.

LUMINAIRE

Performance 1 LED	3,000K Spot	
CPCB / Lumens	3,080	/ 692
Watts	120V	277V
	10W	10W
Operating AMPS	0.083A	0.036A
Lumen Maintenance	L70 @ 50,000 Hrs	
CRI	90+	
Lumens/Watt	69.2	
Spacing Criteria	0.07	

COEFFICIENT OF UTILIZATION - %

Ceiling Reflect %	80			50			30		
Wall Reflect %	50	30	50	30	50	30	50	30	
RCR 0	119	119	111	111	106	106	106	106	
2	104	100	99	96	96	94	96	94	
4	92	87	89	85	87	84	87	84	
6	83	78	81	77	80	76	80	76	
8	76	71	75	70	74	70	74	70	
10	70	65	69	65	68	64	68	64	

Zonal Cavity Method
Effective Floor Cavity Reflectance 20%

ZONAL LUMEN SUMMARY

ZONE	LUMENS	%LUMINAIRE
0-30	530.3	76.6%
0-40	639.5	92.4%
0-60	670.5	96.9%
60-90	21.5	3.1%
0-90	692.0	100%

MULTIPLE UNIT DATA - (RCR 2)

SPACING ON CENTER	INITIAL FOOTCANDLES	WATTS/SQ. FT.
5'	34	0.44
6'	19	0.25
7'	13	0.17
8'	13	0.17
9'	8	0.11

38' x 38' x 10' Room. Workplan located 2-1/2' (30").
Reflectance factor 80%/50%/30%

CANDELAS DISTRIBUTION

DEGREES/VERTICAL	CANDELAS
0	3,080
15	683
30	235
45	25
65	9
75	8
90	0

3,000K, 90+ CRI, Spot, Performance 2

CANDLEPOWER DISTRIBUTION

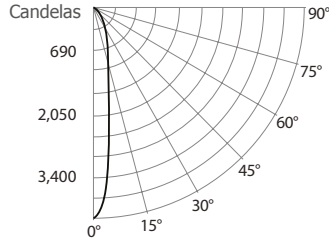

LIGHT CONE

Distance	FC	DIA
06'	111.4	1.7'
08'	62.7	2.3'
10'	40.1	2.8'
12'	27.8	3.4'
14'	20.5	4.0'
16'	15.7	4.5'

Beam: 16°
Beam Edge defined as 50% of Maximum Nadir Candle-power.

LUMINAIRE

Performance 2 LED	3,000K Spot	
CPCB / Lumens	4,010	/ 901.7
Watts	120V	277V
	15W	15W
Operating AMPS	0.125A	0.054A
Lumen Maintenance	L70 @ 50,000 Hrs	
CRI	90+	
Lumens/Watt	60.1	
Spacing Criteria	0.07	

COEFFICIENT OF UTILIZATION - %

Ceiling Reflect %	80			50			30		
Wall Reflect %	50	30	50	30	50	30	50	30	
RCR 0	119	119	111	111	106	106	106	106	
2	104	100	99	96	96	94	96	94	
4	92	87	89	85	87	84	87	84	
6	83	78	81	77	80	76	80	76	
8	76	71	75	70	74	69	74	69	
10	70	65	69	64	68	64	68	64	

Zonal Cavity Method
Effective Floor Cavity Reflectance 20%

ZONAL LUMEN SUMMARY

ZONE	LUMENS	%LUMINAIRE
0-30	690.5	76.6%
0-40	832.5	92.3%
0-60	873.3	96.8%
60-90	28.4	3.2%
0-90	901.7	100%

MULTIPLE UNIT DATA - (RCR 2)

SPACING ON CENTER	INITIAL FOOTCANDLES	WATTS/SQ. FT.
5'	44	0.66
6'	25	0.37
7'	17	0.26
8'	17	0.26
9'	11	0.17

38' x 38' x 10' Room. Workplan located 2-1/2' (30").
Reflectance factor 80%/50%/30%

CANDELAS DISTRIBUTION

DEGREES/VERTICAL	CANDELAS
0	4 010
15	890
30	307
45	33
65	12
75	11
90	0

CONTRASTE

1009, rue du Parc Industriel
Lévis (Québec) G6Z 1C5 Canada
Tel.: 1-888-839-4624
Fax.: 1-877-839-7057
contrastlighting.com
info@contrastlighting.com

© 2017 Contrast Lighting M.L. Inc.
All rights reserved

Contrast Lighting M.L. Inc. reserves the right to make changes in specifications and/or to discontinue any product at any time without notice or obligation and will not be liable for any consequences resulting from the use of this publication.

UR3B

3-1/2" Series Square Adjustable Trim



PHOTOMETRIC DATA

3,000K, 90+ CRI, Narrow Flood, Performance 1

CANDLEPOWER DISTRIBUTION

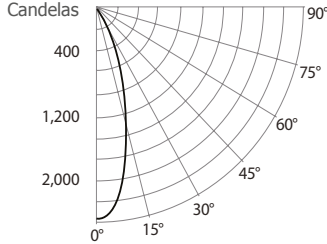

LIGHT CONE

Distance	FC	DIA
06'	65.3	3.5'
08'	36.7	4.7'
10'	23.5	5.9'
12'	16.3	7.1'
14'	12.0	8.3'
16'	9.2	9.5'

Beam: 33°
Beam Edge defined as 50% of Maximum Nadir Candle-power.

LUMINAIRE

Performance 1 LED	3,000K Narrow Flood	
CPCB / Lumens	2 350	/ 852,9
Watts	120V	277V
	10W	10W
Operating AMPS	0.083A	0.036A
Lumen Maintenance	L70 @ 50,000 Hrs	
CRI	90+	
Lumens/Watt	85.2	
Spacing Criteria	0.14	

COEFFICIENT OF UTILIZATION - %

Ceiling Reflect %	80		50		30		
Wall Reflect %	50	30	50	30	50	30	
RCR	0	119	119	111	111	106	106
	2	106	103	102	99	99	97
	4	96	92	93	90	91	88
	6	88	83	86	82	85	81
	8	81	76	80	76	79	75
	10	75	71	74	70	73	70

Zonal Cavity Method
Effective Floor Cavity Reflectance 20%

ZONAL LUMEN SUMMARY

ZONE	LUMENS	%LUMINAIRE
0-30	786.9	92.3%
0-40	846.2	99.2%
0-60	852.9	100 %
60-90	0	0%
0-90	852.9	100%

MULTIPLE UNIT DATA - (RCR 2)

SPACING ON CENTER	INITIAL FOOTCANDLES	WATTS/ SQ. FT.
5'	42	0.44
6'	24	0.25
7'	17	0.17
8'	17	0.17
9'	11	0.11

38' x 38' x 10' Room. Workplan located 2-1/2' (30").
Reflectance factor 80%/50%/30%

CANDELAS DISTRIBUTION

DEGREES/ VERTICAL	CANDELAS
0	2,350
15	1,314
30	251
45	5
60	0
75	0
90	0

3,000K, 90+ CRI, Narrow Flood, Performance 2

DISTRIBUTION DES CANDELAS

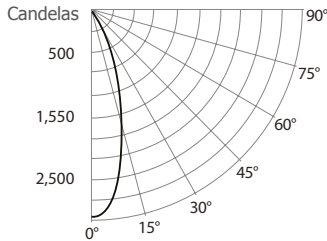

LIGHT CONE

Distance	FC	DIA
06'	85.0	3.5'
08'	47.8	4.7'
10'	30.6	5.9'
12'	21.3	7.1'
14'	15.6	8.3'
16'	12.0	9.5'

Beam: 33°
Beam Edge defined as 50% of Maximum Nadir Candle-power.

LUMINAIRE

Performance 2 LED	3,000K Narrow Flood	
CPCB / Lumens	3,061	/ 1,111.3
Watts	120V	277V
	15W	15W
Operating AMPS	0.125A	0.054A
Lumen Maintenance	L70 @ 50,000 Hrs	
CRI	90+	
Lumens/Watt	74	
Spacing Criteria	0.14	

COEFFICIENT OF UTILIZATION - %

Ceiling Reflect %	80		50		30		
Wall Reflect %	50	30	50	30	50	30	
RCR	0	119	119	111	111	106	106
	2	106	103	102	99	99	97
	4	96	92	93	90	91	88
	6	88	83	86	82	85	81
	8	81	76	80	76	79	75
	10	75	71	74	70	73	70

Zonal Cavity Method
Effective Floor Cavity Reflectance 20%

ZONAL LUMEN SUMMARY

ZONE	LUMENS	%LUMINAIRE
0-30	1,024.9	92.2%
0-40	1,102.2	99.2%
0-60	1,111.2	100 %
60-90	0.1	0%
0-90	1,111.3	100%

MULTIPLE UNIT DATA - (RCR 2)

SPACING ON CENTER	INITIAL FOOTCANDLES	WATTS/ SQ. FT.
5'	55	0.66
6'	31	0.37
7'	22	0.26
8'	22	0.26
9'	14	0.17

38' x 38' x 10' Room. Workplan located 2-1/2' (30").
Reflectance factor 80%/50%/30%

CANDELAS DISTRIBUTION

DEGREES/ VERTICAL	CANDELAS
0	3,061
15	1,712
30	328
45	7
60	1
75	0
90	0

UR3B

3-1/2" Series Square Adjustable Trim



PHOTOMETRIC DATA

3,000K, 90+ CRI, Flood, Performance 1

CANDLEPOWER DISTRIBUTION

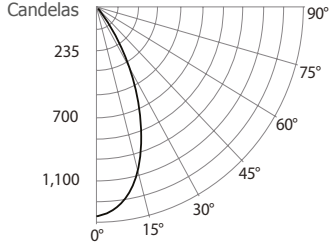

LIGHT CONE

Distance	FC	DIA
06'	37.6	5.4'
08'	21.1	7.2'
10'	13.5	9.0'
12'	9.4	10.8'
14'	6.9	12.6'
16'	5.3	14.4'

Beam: 48°
Beam Edge defined as 50% of Maximum Nadir Candle-power.

LUMINAIRE

Performance 1 LED	3,000K Flood	
CPCB / Lumens	1,353	/ 853.5
Watts	120V	277V
	10W	10W
Operating AMPS	0.083A	0.036A
Lumen Maintenance	L70 @ 50,000 Hrs	
CRI	90+	
Lumens/Watt	85.3	
Spacing Criteria	0.20	

COEFFICIENT OF UTILIZATION - %

Ceiling Reflect %	80			50			30		
Wall Reflect %	50	30	50	30	50	30	50	30	
RCR	0	119	119	111	111	106	106	106	
	2	105	101	100	97	97	94	94	
	4	93	88	89	85	87	84	84	
	6	83	77	81	76	79	75	75	
	8	75	69	73	68	72	68	68	
	10	68	62	66	62	66	61	61	

Zonal Cavity Method
Effective Floor Cavity Reflectance 20%

ZONAL LUMEN SUMMARY

ZONE	LUMENS	%LUMINAIRE
0-30	701.7	82.2%
0-40	822.3	96.3%
0-60	851.8	99.8%
60-90	1.6	0.2%
0-90	853.5	100%

MULTIPLE UNIT DATA - (RCR 2)

SPACING ON CENTER	INITIAL FOOTCANDLES	WATTS/SQ. FT.
5'	42	0.44
6'	23	0.25
7'	16	0.17
8'	16	0.17
9'	10	0.11

38' x 38' x 10' Room. Workplan located 2-1/2' (30").
Reflectance factor 80%/50%/30%

CANDELAS DISTRIBUTION

DEGREES/ VERTICAL	CANDELAS
0	1,353
15	1,070
30	374
45	30
60	3
75	0
90	0

3,000K, 90+ CRI, Flood, Performance 2

CANDLEPOWER DISTRIBUTION

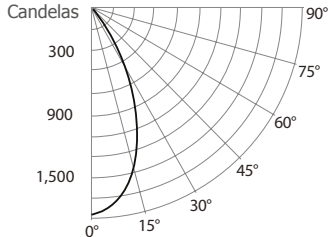

LIGHT CONE

Distance	FC	DIA
06'	48.9	5.4'
08'	27.5	7.2'
10'	17.6	9.0'
12'	12.2	10.8'
14'	9.0	12.6'
16'	6.9	14.4'

Beam: 48°
Beam Edge defined as 50% of Maximum Nadir Candle-power.

LUMINAIRE

Performance 2 LED	3,000K Flood	
CPCB / Lumens	1,762	/ 1,111.5
Watts	120V	277V
	15W	15W
Operating AMPS	0.125A	0.054A
Lumen Maintenance	L70 @ 50,000 Hrs	
CRI	90+	
Lumens/Watt	74.1	
Spacing Criteria	0.20	

COEFFICIENT OF UTILIZATION - %

Ceiling Reflect %	80			50			30		
Wall Reflect %	50	30	50	30	50	30	50	30	
RCR	0	119	119	111	111	106	106	106	
	2	105	101	100	97	97	94	94	
	4	93	88	89	85	87	84	84	
	6	83	77	81	76	79	75	75	
	8	75	69	73	68	72	68	68	
	10	68	62	66	62	66	61	61	

Zonal Cavity Method
Effective Floor Cavity Reflectance 20%

ZONAL LUMEN SUMMARY

ZONE	LUMENS	%LUMINAIRE
0-30	914.2	82.2%
0-40	1,071.3	96.4%
0-60	1,109.7	98.8%
60-90	1.8	0.2%
0-90	1,111.5	100%

MULTIPLE UNIT DATA - (RCR 2)

SPACING ON CENTER	INITIAL FOOTCANDLES	WATTS/SQ. FT.
5'	54	0.66
6'	30	0.37
7'	21	0.26
8'	21	0.26
9'	14	0.17

38' x 38' x 10' Room. Workplan located 2-1/2' (30").
Reflectance factor 80%/50%/30%

CANDELAS DISTRIBUTION

DEGREES/ VERTICAL	CANDELAS
0	1,762
15	1,394
30	487
45	39
60	4
75	0
90	0