

UR3D

3-1/2" Series Round Adjustable Regressed Trim



Project _____

Notes _____

Fixture Type _____

Date _____



UR3D-25AN (illustrated)

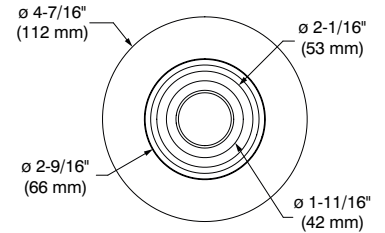
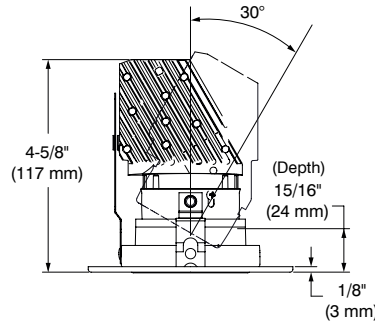

SPECIFICATIONS

LED MODULE

SOLID COLORS

Lumileds Luxeon CoB
 2,700K - CRI: 80+ and 90+
 3,000K - CRI: 80+ and 90+
 3,500K - CRI: 90+
 4,000K - CRI: 90+
 Lumens Maintenance:
 L₇₀ @ 50,000 hours
 Color Binning: 3 SDCM

LED MODULE (CONT'D)

WARM DIMMING (WD)

LED module mimicking the halogen lamp dimming conditions by lowering color temperature from 3,050K at full intensity down to 1,800K at low-end while ensuring 90+ CRI throughout the whole process.
 Lumens Maintenance:
 L₇₀ @ 50,000 hours
 Color Binning: 3 SDCM

DELIVERED LUMENS

Performance 1 (10W):

816 lumens @ 3,000K, 81.6 lms/W

Performance 2 (15W):

1,063 lumens @ 3,000K, 70.8 lms/W

Warm Dimming (WD)

521 lumens @ 3,000K, 34.7 lms/W

OPTIC SYSTEM*

Optical reflectors available:
 Spot, Narrow Flood, Flood

Standard

Spot (S)	16°
Narrow Flood (M)	32°
Flood (L)	48°

* Average beams shown. Consult .ies files on our Website for more details.

LENSES

Without lens (std)
 Clear (C), Frosted (F)
 Honeycomb (H), Linear (L)
 Prismatic (P), Solite (S)

POWER SUPPLY

(Determined by the choice of housing)

120V, 277V or 120V/277V
 Several driver models available in two performances (10W and 15W) and in two dimming options (ELV and 0-10V).
 See housing specification sheets for more details.

HEAT SINK

High quality aluminum injected heat sink ensuring maximum heat dissipation.

TRIM

Powder coat painted or plated die-formed steel. Tilt: up to 30°.

PAINTED REFLECTORS

Natural Anodized Aluminum (AN)
 Matte White (11)
 Matte Black (22)

CEILING CUTOUT

ø 4-1/4" (108 mm)

UR3D

3-1/2" Series Round Adjustable Regressed Trim



SPECIFICATIONS (CONT'D)

COMPATIBLE HOUSINGS

	Remodel Housings	New Construction Housings	IC Housings
Performance 1 10W Warm Dimming not compatible	IC and Air Tight REUR3-120D1 REUR3-120E1 REUR3-277D1 REUR3-UV1	IC and Air Tight NWUR3-120D1 NWUR3-120E1 NWUR3-277D1 NWUR3-UV1 Emergency Driver Non-IC and Air Tight NWUR3-120D1-EM NWUR3-120E1-EM NWUR3-277D1-EM NWUR3-UV1-EM	Air Tight ISUR3-120D1 ISUR3-120E1 ISUR3-277D1 ISUR3-UV1 Chicago Plenum and Polyurethane Air Tight ISUR3-120D1P ISUR3-120E1P ISUR3-277D1P ISUR3-UV1P
Performance 2 15W MAX	Non-IC and Air Tight REUR3-120D2 REUR3-120E2 REUR3-120EB2 REUR3-2772 REUR3-277D2 REUR3-UV2	Non-IC and Air Tight NWUR3-120D2 NWUR3-120E2 NWUR3-120EB2 NWUR3-2772 NWUR3-277D2 NWUR3-UV2 Emergency Driver Non-IC and Air Tight NWUR3-120D2-EM NWUR3-120E2-EM NWUR3-120EB2-EM NWUR3-2772-EM NWUR3-277D2-EM NWUR3-UV2-EM	Air Tight ISUR3-120D2 ISUR3-120E2 ISUR3-120EB2 ISUR3-2772 ISUR3-277D2 ISUR3-UV2 Chicago Plenum Air Tight ISUR3-120D2P ISUR3-120E2P ISUR3-120EB2P ISUR3-2772P ISUR3-277D2P ISUR3-UV2P

For dimming, please visit our Web site frequently to find our suggested compatible dimmers list:
www.contrastlighting.com

Contraste suggests ordering
EB2 (ELV (+Value)/15W), D2 (0-10V/15W)
 or
UV2 (ELV/0-10V/15W)
 dimming type and performance to use with Warm Dimming

CERTIFICATION

cULus **E343977** for damp locations
 Certified under California Energy Commission according to reference Appendix JA8

WARRANTY

1 year on components against manufacturing defects
 5 years on LED arrays and drivers

SPECIFICATION SHEET

UR3D

3-1/2" Series Round Adjustable Regressed Trim



CODIFICATION EXAMPLE

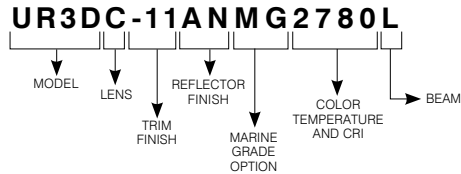

ORDERING CODES

MODEL	LENSES	TRIM FINISHES	REFLECTOR FINISHES	MARINE GRADE	COLOR TEMPERATURES AND CRI	BEAMS
UR3D						
UR3D	Without lens (std)	-01 White	PAINTED	MG (optional)	2780 2,700K (80+ CRI)	S Spot (16°)
C	Clear	-03SA Satin Gold	AN Natural Anodized Aluminum 11 Matte White 22 Matte Black (Not available with -03SA finish)	May be applied on finishes: -01, -11, -22 and -25	3080 3,000K (80+ CRI)	M Narrow Flood (32°)
F	Frosted	-04BR Brushed Chrome			2790 2,700K (90+ CRI)	L Flood (48°)
H	Honeycomb	-11 Matte White			3090 3,000K (90+ CRI)	
L	Linear	-12BR Brushed Nickel			3590 3,500K (90+ CRI)	
P	Prismatic	-13 Satin Nickel			4090 4,000K (90+ CRI)	
S	Solite	-22 Matte Black		WD90 Warm Dimming (90+ CRI)		
		-25 Polar Grey				
		(-25 finish perfectly matches with AN reflector finish)			Compatible with 15W drivers only (EB2, D2 and UV2)	

GOOF RINGS

Goof rings will help you fix larger than necessary or damaged ceiling cutouts.

- Code: RR3-01** (White)
RR3-03SA (Satin Gold)
RR3-04BR (Brushed Chrome)
RR3-11 (Matte White)
RR3-12BR (Brushed Nickel)
RR3-13 (Satin Nickel)
RR3-22 (Matte Black)
RR3-25 (Polar Grey)

Outside diameter: ø 6-1/8" (156 mm)
 Inside diameter: ø 3-11/16" (94 mm)

CONTRASTE

1009, rue du Parc Industriel
 Lévis (Québec) G6Z 1C5 Canada
 Tel.: 1-888-839-4624
 Fax.: 1-877-839-7057
 contrastlighting.com
 info@contrastlighting.com

© 2017 Contrast Lighting M.L. Inc.
 All rights reserved

Contrast Lighting M.L. Inc. reserves the right to make changes in specifications and/or to discontinue any product at any time without notice or obligation and will not be liable for any consequences resulting from the use of this publication.

UR3D

3-1/2" Series Round Adjustable Regressed Trim



PHOTOMETRIC DATA

In order to obtain the accurate photometric data, multiply the lumens relative to your product selection by the applicable factor(s) below tables. Take note these factors also need to be implemented in the .ies files available on our website.

With performance 1 housing

	Spot (16°)		Narrow Flood (32°)		Flood (48°)	
2,700K with 80+ CRI	646 lm	64.6 lm/w	797 lm	79.7 lm/w	797 lm	79.7 lm/w
3,000K with 80+ CRI	662 lm	66.2 lm/w	816 lm	81.6 lm/w	816 lm	81.6 lm/w
2,700K with 90+ CRI	537 lm	53.7 lm/w	662 lm	66.2 lm/w	662 lm	66.2 lm/w
3,000K with 90+ CRI	555 lm	55.5 lm/w	684 lm	68.4 lm/w	684 lm	68.4 lm/w
3,500K with 90+ CRI	586 lm	58.6 lm/w	722 lm	72.2 lm/w	722 lm	72.2 lm/w
4,000K with 90+ CRI	601 lm	60.1 lm/w	742 lm	74.2 lm/w	742 lm	74.2 lm/w
Warm Dimming with 90+ CRI	Not available with performance 1 housings					

Performance 1 Housings Factors	
XXUR-120E1	0.90
XXUR-120D1 or XXUR-277D1	1

With performance 2 housing

	Spot (16°)		Narrow Flood (32°)		Flood (48°)	
2,700K with 80+ CRI	841 lm	56 lm/w	1038 lm	69.2 lm/w	1038 lm	69.2 lm/w
3,000K with 80+ CRI	862 lm	57.4 lm/w	1063 lm	70.8 lm/w	1063 lm	70.8 lm/w
2,700K with 90+ CRI	699 lm	46.6 lm/w	862 lm	57.4 lm/w	862 lm	57.4 lm/w
3,000K with 90+ CRI	722 lm	48.1 lm/w	891 lm	59.4 lm/w	891 lm	59.4 lm/w
3,500K with 90+ CRI	763 lm	50.8 lm/w	940 lm	62.6 lm/w	940 lm	62.6 lm/w
4,000K with 90+ CRI	783 lm	52.2 lm/w	966 lm	64.4 lm/w	966 lm	64.4 lm/w
Warm Dimming with 90+ CRI	422 lm	28.1 lm/w	521 lm	34.7 lm/w	521 lm	34.7 lm/w

Performance 2 Housings Factors	
XXUR-120E2	0.95
XXUR-120EB2, XXUR-120D2, XXUR-2772 or XXUR-277D2	1

Lens Factors	
STD	1
C	0.97
F	0.68
H	0.54

Reflectors Factors	
AN	0.99
11	1
22	0.97

UR3D

3-1/2" Series Round Adjustable Regressed Trim



PHOTOMETRIC DATA

3,000K, 90+ CRI, Spot, Performance 1

CANDLEPOWER DISTRIBUTION

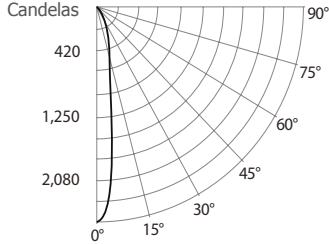

LIGHT CONE

Distance	FC	DIA
06'	68.6	1.7'
08'	38.6	2.3'
10'	24.7	2.8'
12'	17.2	3.4'
14'	12.6	4.0'
16'	9.7	4.5'

Beam: 16"
Beam Edge defined as 50% of Maximum Nadir Candle-power.

LUMINAIRE

Performance 1 LED	3,000K Spot	
CPCB / Lumens	2,470	/ 556.7
Watts	120V	277V
	10W	10W
Operating AMPS	0.083A	0.036A
Lumen Maintenance	L70 @ 50,000 Hrs	
CRI	90+	
Lumens/Watt	55.7	
Spacing Criteria	0.07	

COEFFICIENT OF UTILIZATION - %

Ceiling Reflect %	80			50			30		
Wall Reflect %	50	30	50	30	50	30	50	30	
RCR 0	119	119	111	111	106	106	106	106	
2	104	100	99	96	96	94	94	94	
4	92	87	89	85	87	84	84	84	
6	83	78	81	77	80	76	76	76	
8	76	71	74	70	74	69	69	69	
10	70	65	69	64	68	64	64	64	

Zonal Cavity Method
Effective Floor Cavity Reflectance 20%

ZONAL LUMEN SUMMARY

ZONE	LUMENS	%LUMINAIRE
0-30	425.3	76.4%
0-40	512.7	92.1%
0-60	5538.1	96.7%
60-90	18.6	3.3%
0-90	556.7	100%

MULTIPLE UNIT DATA - (RCR 2)

SPACING ON CENTER	INITIAL FOOTCANDLES	WATTS/SQ. FT.
5'	27	0.44
6'	15	0.25
7'	11	0.17
8'	11	0.17
9'	7	0.11

38' x 38' x 10' Room. Workplan located 2-1/2' (30").
Reflectance factor 80%/50%/30%

CANDELAS DISTRIBUTION

DEGREES/VERTICAL	CANDELAS
0	2,470
15	548
30	189
45	20
65	8
75	7
90	0

3,000K, 90+ CRI, Spot, Performance 2

CANDLEPOWER DISTRIBUTION

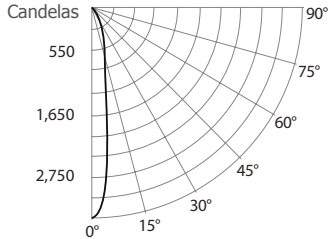

LIGHT CONE

Distance	FC	DIA
06'	89.3	1.7'
08'	50.2	2.3'
10'	32.1	2.8'
12'	22.3	3.4'
14'	16.4	4.0'
16'	12.6	4.5'

Beam: 16"
Beam Edge defined as 50% of Maximum Nadir Candle-power.

LUMINAIRE

Performance 2 LED	3,000K Spot	
CPCB / Lumens	3,214	/ 723.3
Watts	120V	277V
	15W	15W
Operating AMPS	0.125A	0.054A
Lumen Maintenance	L70 @ 50,000 Hrs	
CRI	90+	
Lumens/Watt	72.3	
Spacing Criteria	0.07	

COEFFICIENT OF UTILIZATION - %

Ceiling Reflect %	80			50			30		
Wall Reflect %	50	30	50	30	50	30	50	30	
RCR 0	119	119	111	111	106	106	106	106	
2	104	100	99	96	96	94	94	94	
4	92	87	89	85	87	84	84	84	
6	83	78	81	77	80	76	76	76	
8	76	71	75	70	74	69	69	69	
10	70	65	69	64	68	64	64	64	

Zonal Cavity Method
Effective Floor Cavity Reflectance 20%

FLUX LUMINEUX ZONALE

ZONE	LUMENS	%LUMINAIRE
0-30	553.5	76.5%
0-40	667.2	92.2%
0-60	699.8	96.7%
60-90	23.5	3.3%
0-90	723.3	100%

MULTIPLE UNIT DATA - (RCR 2)

SPACING ON CENTER	INITIAL FOOTCANDLES	WATTS/SQ. FT.
5'	35	0.66
6'	20	0.37
7'	14	0.26
8'	14	0.26
9'	9	0.17

38' x 38' x 10' Room. Workplan located 2-1/2' (30").
Reflectance factor 80%/50%/30%

CANDELAS DISTRIBUTION

DEGREES/VERTICAL	CANDELAS
0	3,214
15	713
30	246
45	27
65	10
75	9
90	0

UR3D

3-1/2" Series Round Adjustable Regressed Trim



PHOTOMETRIC DATA

3,000K, 90+ CRI, Narrow Flood, Performance 1

CANDLEPOWER DISTRIBUTION

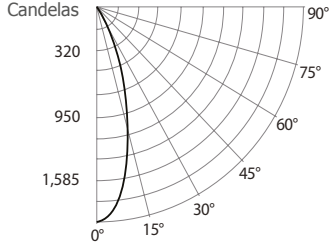

LIGHT CONE

Distance	FC	DIA
06'	52.3	3.5'
08'	29.4	4.7'
10'	18.8	5.9'
12'	13.1	7.1'
14'	9.6	8.3'
16'	7.4	9.5'

Beam: 33°
Beam Edge defined as 50% of Maximum Nadir Candle-power.

LUMINAIRE

Performance 1 LED	3,000K Narrow Flood	
CPCB / Lumens	1,884	/ 683.6
Watts	120V	277V
	10W	10W
Operating AMPS	0.083A	0.036A
Lumen Maintenance	L70 @ 50,000 Hrs	
CRI	90+	
Lumens/Watt	68.4	
Spacing Criteria	0.14	

COEFFICIENT OF UTILIZATION - %

Ceiling Reflect %	80			50			30		
Wall Reflect %	50	30	50	30	50	30	50	30	
RCR 0	119	119	111	111	106	106	106	106	
2	106	103	102	99	99	97	99	97	
4	96	92	93	90	91	88	91	88	
6	88	83	86	82	85	81	85	81	
8	81	76	80	76	79	75	79	75	
10	75	71	74	70	73	70	73	70	

Zonal Cavity Method
Effective Floor Cavity Reflectance 20%

ZONAL LUMEN SUMMARY

ZONE	LUMENS	%LUMINAIRE
0-30	630.7	92.3%
0-40	678.3	99.2%
0-60	683.6	100%
60-90	0.000	0%
0-90	683.6	100%

MULTIPLE UNIT DATA - (RCR 2)

SPACING ON CENTER	INITIAL FOOTCANDLES	WATTS/SQ. FT.
5'	34	0.44
6'	19	0.25
7'	13	0.17
8'	13	0.17
9'	8	0.11

38' x 38' x 10' Room. Workplan located 2-1/2' (30").
Reflectance factor 80%/50%/30%

CANDELAS DISTRIBUTION

DEGREES/VERTICAL	CANDELAS
0	1,884
15	1,054
30	202
45	4
60	0
75	0
90	0

3,000K, 90+ CRI, Narrow Flood, Performance 2

CANDLEPOWER DISTRIBUTION

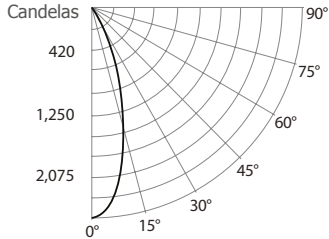

LIGHT CONE

Distance	FC	DIA
06'	68.2	3.5'
08'	38.3	4.7'
10'	24.5	5.9'
12'	17.04	7.1'
14'	12.5	8.3'
16'	9.6	9.5'

Beam: 33°
Beam Edge defined as 50% of Maximum Nadir Candle-power.

LUMINAIRE

Performance 2 LED	3,000K Narrow Flood	
CPCB / Lumens	2,454	/ 891
Watts	120V	277V
	15W	15W
Operating AMPS	0.125A	0.054A
Lumen Maintenance	L70 @ 50,000 Hrs	
CRI	90+	
Lumens/Watt	59.4	
Spacing Criteria	0.14	

COEFFICIENT OF UTILIZATION - %

Ceiling Reflect %	80			50			30		
Wall Reflect %	50	30	50	30	50	30	50	30	
RCR 0	119	119	111	111	106	106	106	106	
2	106	103	102	99	99	97	99	97	
4	96	92	93	90	91	88	91	88	
6	88	83	86	82	85	81	85	81	
8	81	76	80	76	79	75	79	75	
10	75	71	74	70	73	70	73	70	

Zonal Cavity Method
Effective Floor Cavity Reflectance 20%

ZONAL LUMEN SUMMARY

ZONE	LUMENS	%LUMINAIRE
0-30	821.9	92.2%
0-40	884.0	99.2%
0-60	891.0	100%
60-90	0.000	0%
0-90	891	100%

MULTIPLE UNIT DATA - (RCR 2)

SPACING ON CENTER	INITIAL FOOTCANDLES	WATTS/SQ. FT.
5'	44	0.66
6'	25	0.37
7'	17	0.26
8'	17	0.26
9'	11	0.17

38' x 38' x 10' Room. Workplan located 2-1/2' (30").
Reflectance factor 80%/50%/30%

CANDELAS DISTRIBUTION

DEGREES/VERTICAL	CANDELAS
0	2,454
15	1,373
30	263
45	6
60	0
75	0
90	0

UR3D

3-1/2" Series Round Adjustable Regressed Trim



PHOTOMETRIC DATA

3,000K, 90+ CRI, Flood, Performance 1

CANDLEPOWER DISTRIBUTION

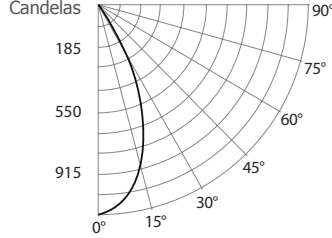

LIGHT CONE

Distance	FC	DIA
06'	30.2	5.4'
08'	16.9	7.2'
10'	10.9	9.0'
12'	7.5	10.8'
14'	5.5	12.6'
16'	4.2	14.4'

Beam: 48°
Beam Edge defined as 50% of Maximum Nadir Candle-power.

LUMINAIRE

Performance 1 LED	3,000K Flood	
CPCB / Lumens	1,086	/ 684.6
Watts	120V	277V
	10W	10W
Operating AMPS	0.083A	0.036A
Lumen Maintenance	L70 @ 50,000 Hrs	
CRI	90+	
Lumens/Watt	68.5	
Spacing Criteria	0.20	

COEFFICIENT OF UTILIZATION - %

Ceiling Reflect %	80			50			30		
Wall Reflect %	50	30	50	30	50	30	50	30	
RCR 0	119	119	111	111	106	106	106	106	
2	105	101	100	97	97	94	94	94	
4	93	88	89	85	87	84	84	84	
6	83	77	81	76	79	75	75	75	
8	75	69	73	68	72	68	68	68	
10	68	62	67	62	66	62	62	62	

Zonal Cavity Method
Effective Floor Cavity Reflectance 20%

ZONAL LUMEN SUMMARY

ZONE	LUMENS	%LUMINAIRE
0-30	563.2	82.3%
0-40	660.1	96.4%
0-60	683.7	99.9%
60-90	0.9	0.1%
0-90	684.6	100%

MULTIPLE UNIT DATA - (RCR 2)

SPACING ON CENTER	INITIAL FOOTCANDLES	WATTS/SQ. FT.
5'	33	0.44
6'	19	0.25
7'	13	0.17
8'	13	0.17
9'	8	0.11

38' x 38' x 10' Room. Workplan located 2-1/2' (30").
Reflectance factor 80%/50%/30%

CANDELAS DISTRIBUTION

DEGREES/VERTICAL	CANDELAS
0	1,086
15	859
30	300
45	24
60	2
75	0
90	0

3,000K, 90+ CRI, Flood, Performance 2

CANDLEPOWER DISTRIBUTION

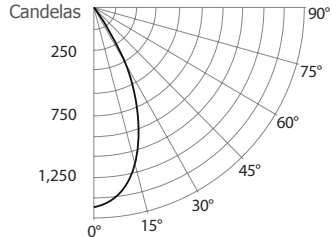

LIGHT CONE

Distance	FC	DIA
06'	39.2	5.4'
08'	22.1	7.2'
10'	14.1	9.0'
12'	9.8	10.8'
14'	7.2	12.6'
16'	5.5	14.4'

Beam: 48°
Beam Edge defined as 50% of Maximum Nadir Candle-power.

LUMINAIRE

Performance 2 LED	3,000K Flood	
CPCB / Lumens	1,412	/ 891.1
Watts	120V	277V
	15W	15W
Operating AMPS	0.125A	0.054A
Lumen Maintenance	L70 @ 50,000 Hrs	
CRI	90+	
Lumens/Watt	59.4	
Spacing Criteria	0.20	

COEFFICIENT OF UTILIZATION - %

Ceiling Reflect %	80			50			30		
Wall Reflect %	50	30	50	30	50	30	50	30	
RCR 0	119	119	111	111	106	106	106	106	
2	105	101	100	97	97	94	94	94	
4	93	88	89	85	87	84	84	84	
6	83	77	81	76	79	75	75	75	
8	75	69	73	68	72	68	68	68	
10	68	62	66	62	66	62	62	62	

Zonal Cavity Method
Effective Floor Cavity Reflectance 20%

ZONAL LUMEN SUMMARY

ZONE	LUMENS	%LUMINAIRE
0-30	733.0	82.3%
0-40	858.9	96.4%
0-60	889.5	99.8%
60-90	1.6	0.2%
0-90	891.1	100%

MULTIPLE UNIT DATA - (RCR 2)

SPACING ON CENTER	INITIAL FOOTCANDLES	WATTS/SQ. FT.
5'	43	0.66
6'	24	0.37
7'	17	0.26
8'	17	0.26
9'	11	0.17

38' x 38' x 10' Room. Workplan located 2-1/2' (30").
Reflectance factor 80%/50%/30%

CANDELAS DISTRIBUTION

DEGREES/VERTICAL	CANDELAS
0	1,412
15	1,118
30	390
45	32
60	3
75	0
90	0