

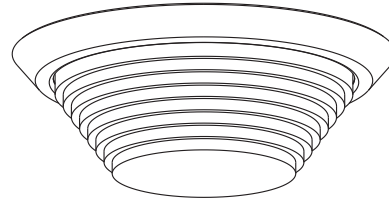







SPECIFICATION SHEET

4" 2000 SERIES

A2000VS

ROUND SHOWER TRIM WITH FROSTED STEPPED GLASS



	Wet Location YES
	Compact Fluorescent 13W, 18W, 26W or 32W
	PAR PAR20 35-50W
	Glass 2 available colors : natural and blue. White trim with natural glass : A2000VS-01 White trim with blue glass : A2010VS-01
	Insulated ceiling housing ISCA2000, ISF2000, ISF2000U13,18, ISF2000LU18
	New construction housing NW2000CA, NWF2000U13,18,26, NWF2000LU18,26,32
	Remodel housing CA2000, F2000, F2000L, F2000U13,18,26, F2000LU18,26,32

COMPATIBLE HOUSINGS

35W PAR20	13W CF	18W CF	26W CF	32W CF
ISCA2000	F2000 F2000L ISF2000 ISF2000L	F2000U18 F2000LU18 ISF2000U18 ISF2000LU18	F2000U26 F2000LU26 NWF2000U26 NWF2000LU26	F2000LU32 NWF2000LU32
50W PAR20 CA2000 NW2000CA	F2000U13 ISF2000U13 NWF2000U13	NWF2000U18 NWF2000LU18		

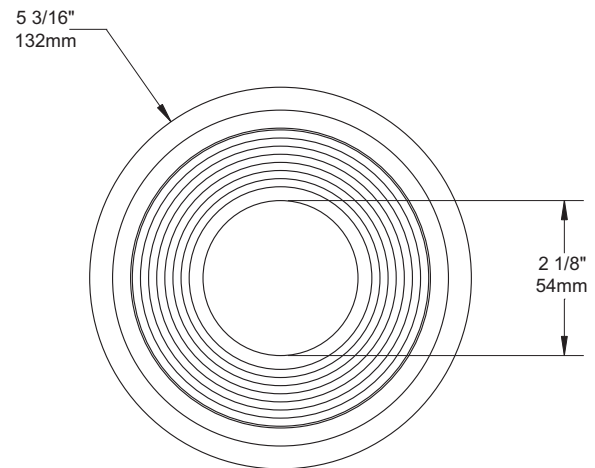
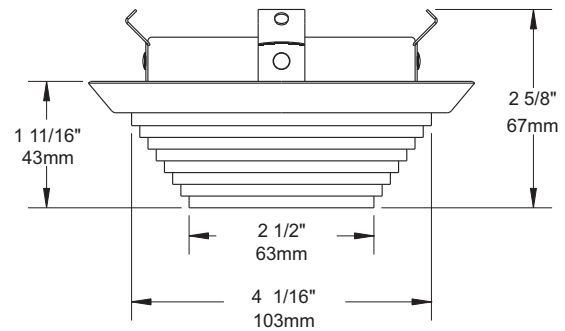



ENERGY STAR Requirements
120 Volt ONLY

This trim meets every ENERGY STAR requirements when combined with the following housings :

F2000U13	F2000LU18	F2000U26	NWF2000LU26
NWF2000U13	NWF2000U18	F2000LU26	NWF2000D26
F2000U18	NWF2000LU18	NWF2000U26	NWF2000LD26

TRIM FINISHES

- | | | |
|--------------|--------------------------|----------------------|
| -01 WHITE | -04BR BRUSHED CHROME | -08 ANTIQUE SILVER |
| -02 BLACK | -05 ARCHITECTURAL BRONZE | -11 MATTE WHITE |
| -03 24K GOLD | -06 ANTIQUE COPPER | -12BR BRUSHED NICKEL |
| -04 CHROME | -07 ANTIQUE BRASS | -13 SATIN NICKEL |
| | | -14 ALMOND |

Unless otherwise indicated, trims are for **interior use only**. For exterior use and up to wet conditions, **MARINE GRADE** treatment is **recommended**. Available for finishes -01, -02, -05, -06, -11 and -14 only.

Project _____

Representative _____

CONTRAST
L I G H T I N G

1009, rue du Parc Industriel, Saint-Jean-Chrysostome, Qc, CAN G6Z 1C5 Tel.: 1-888-839-4624 Fax : 1-877-839-7057
info@contrastlighting.com
www.contrastlighting.com

MADE IN CANADA

UL LISTED
Certified UL Standards

JUNE 2010