

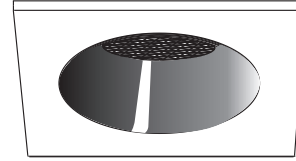







# SPECIFICATION SHEET

4" 2000 SERIES

# A2100

SQUARE TRIM



	YES
<b>Damp Location</b>	
	PAR20 50W
<b>PAR</b>	
	PAR20 39W HIGH INTENSITY DISCHARGE (HID)
<b>PAR20 HID</b>	
	<b>Standard : painted Black.</b> Painted White baffle is available with white trim (A2100-01W). Painted Matte white baffle is available with matte white trim (A2100-11W).
<b>Baffle</b>	
	<b>Insulated ceiling housing</b> ISCA2000
	<b>New construction housing</b> NW2000CA
	<b>Remodel housing</b> CA2000, CA2000MH
<b>Remodel housing</b>	

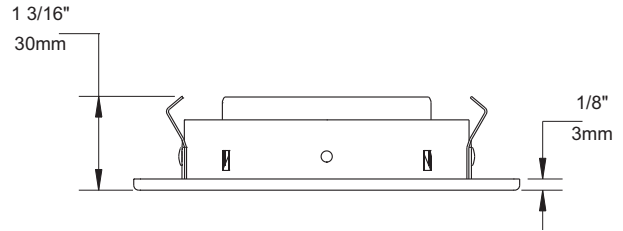

## COMPATIBLE HOUSINGS

50W PAR20	39W PAR20 HID
CA2000 NW2000CA ISCA2000	CA2000MH

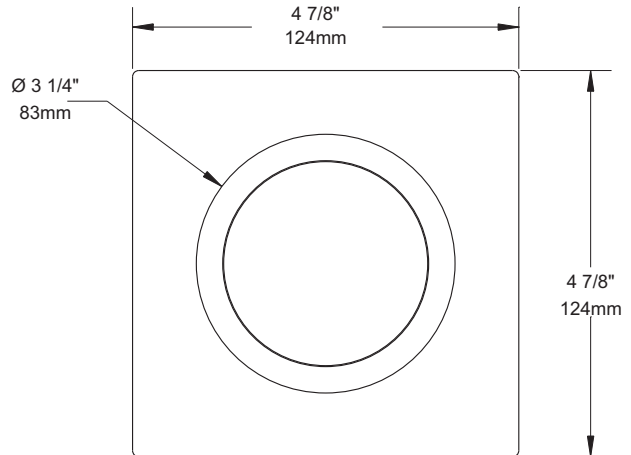

## TRIM FINISHES

-01 WHITE	-04BR BRUSHED CHROME	-08 ANTIQUE SILVER
-02 BLACK	-05 ARCHITECTURAL BRONZE	-11 MATTE WHITE
-03 24K GOLD	-06 ANTIQUE COPPER	-12BR BRUSHED NICKEL
-04 CHROME	-07 ANTIQUE BRASS	-13 SATIN NICKEL
		-14 ALMOND

Unless otherwise indicated, trims are for **interior use only**. For exterior use and up to wet conditions, **MARINE GRADE** treatment is **recommended**. Available for finishes -01, -02, -05, -06, -11 and -14 only.



Project \_\_\_\_\_

Representative \_\_\_\_\_

**CONTRAST**  
LIGHTING

1009, rue du Parc Industriel, Saint-Jean-Chrysostome, Qc, CAN G6Z 1C5 Tel.: 1-888-839-4624 Fax : 1-877-839-7057  
info@contrastlighting.com  
www.contrastlighting.com

APRIL 2010