









**"NON-IC" TYPE HOUSING**

CA2575

	<b>yes</b>
<b>VOLTAGE</b>	<b>120 VOLTS</b>
	
	
	<b>PAR30 75W max.</b>
	
	
	
	<b>T°C 100°C No 027</b>
<b>BX Length</b>	<b>5" (127 mm)</b>
<b>UL number</b>	<b>E 174023</b>
<b>E Electronic M Magnetic C Short L Long</b>	

 **OD Cut : 4 5/8" (117 mm)**

**NOTES:**  
For ceiling without insulation  
Below ceiling access

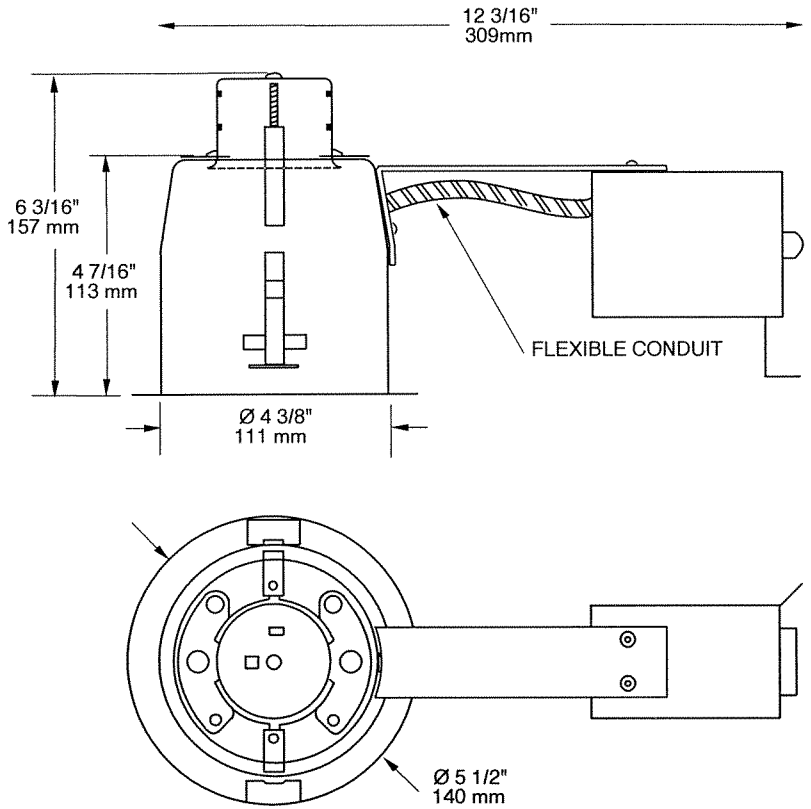

**PROJECT**

Your Project: \_\_\_\_\_

\_\_\_\_\_

Representative: \_\_\_\_\_

