



SPECIFICATION SHEET

PROJECT No:

"NON-IC" TYPE HOUSING

NW3000LE 120/12V

-  **yes**

-  **VOLTAGE 120 VOLTS**

-  **12 V 50W max.**

- 

- 

-  **Electronic Transformer**

-  **120V / 12V**

-  **T°C 125°C No 032**

- Double top**

UL number : **E 174023**

E Electronic **M** Magnetic **C** Short **L** Long

AVAILABLE TRIMS

- T3000, T3100, T3200, T3250, T3260, T3300
- T3400, T3450, T3500, T3600, T3650, T3700
- T3800, T3850, T3900,
- S3400, S3450, S3500, **50W MAX**
- S3400D, S3450D, S3500D, **42W MAX**

 **OD Cut : 3 3/4" (95 mm)**

NOTES:
For ceiling without insulation
Below ceiling access

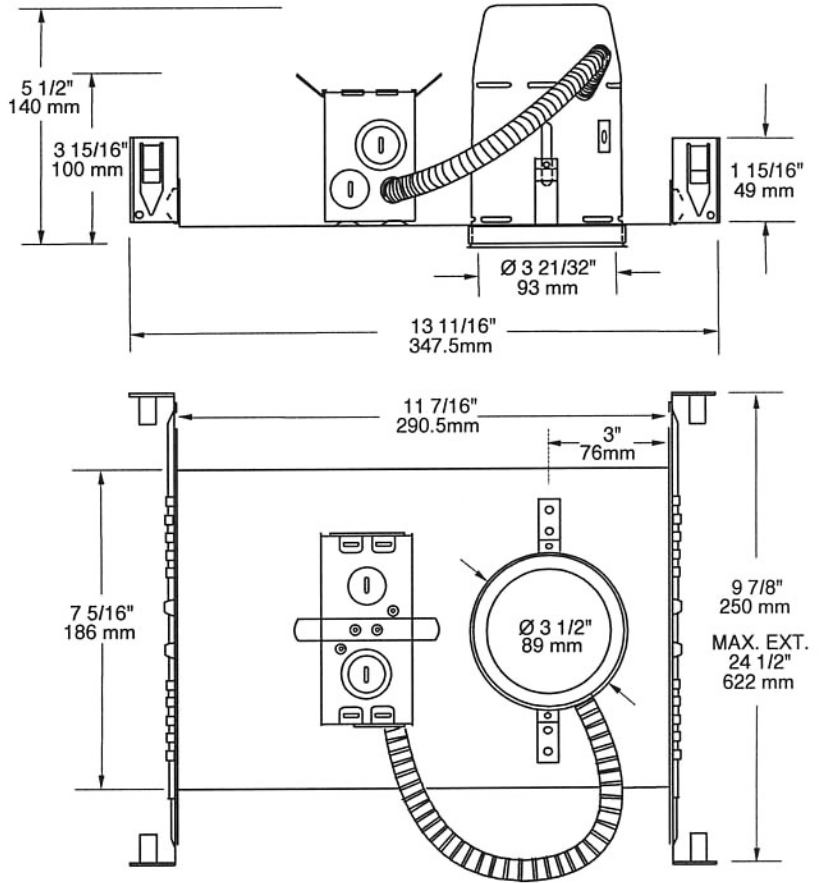

PROJECT

Your Project: _____

Representative: _____